

Data Sheet

Description

Avago Technologies's MGA-30489 is a 0.25W highly dynamic range Driver Amplifier MMIC, housed in a SOT-89 standard plastic package. The device features excellent input and output return loss, highly linear performance. The device can be easily matched to obtain optimum power and linearity.

MGA-30489 is especially ideal for 50Ω wireless infrastructure application such as Cellular/PCS/W-CDMA/WLL and new generation wireless technologies systems in the 250MHz to 3GHz frequency range applications. With high IP3 and low noise figure and wideband operation, the MGA-30489 may be utilized as a driver amplifier in the transmit chain and as a second stage LNA in the receive chain.

Pin connections and Package Marking

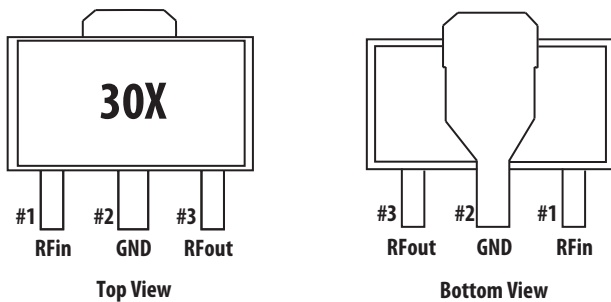

Note :
Top View : Package marking provides orientation and identification
"30" = Device Code
"X" = Date Code character identifies month of manufacturing

Attention: Observe precautions for handling electrostatic sensitive devices.
ESD Machine Model = 80 V
ESD Human Body Model = 350 V
Refer to Avago Application Note A004R: Electrostatic Discharge, Damage and Control.

Features

- ROHS compliant
- Halogen free
- Very high linearity at low DC bias power^[1]
- Low noise figure
- High OIP3
- Advanced enhancement mode PHEMT Technology
- Excellent uniformity in product specification
- SOT-89 standard package

Specifications

At 1.9GHz, Vdd = 5V, Idd = 97mA (typ) @ 25°C

- OIP3 = 39 dBm
- Noise Figure = 3 dB
- Gain = 13.3 dB
- P1dB = 23.3 dBm
- IRL = 15dB, ORL = 14.5dB

Notes:

1. The MGA-30489 has a superior LFOM of 13dB. Linearity Figure of Merit (LFOM) is essentially OIP3 divided by DC bias power. There are few devices in the market that can match its combination of high linearity and low noise figure at the low DC bias power of 5V/97mA.

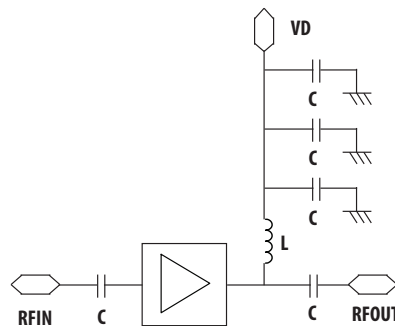

Figure 1. Simplified Schematic diagram

MGA-30489 Absolute Maximum Rating [1]

| Symbol | Parameter | Units | Absolute Maximum |
|--------------|--------------------------------------|-------|------------------|
| $I_{d,max}$ | Drain Current | mA | 180 |
| $V_{d,max}$ | Devices voltage, RF output to ground | V | 8.4 |
| P_{diss} | Power Dissipation [2] | mW | 1512 |
| $P_{in,max}$ | CW RF Input Power | dBm | 24 |
| $T_{j,max}$ | Junction Temperature | °C | 150 |
| T_{stg} | Storage Temperature | °C | -65 to 150 |

Thermal Resistance

Thermal Resistance [3]
($V_d = 5.0\text{ V}$) $\theta_{jc} = 50.50^\circ\text{C/W}$

Notes:

1. Operation of this device in excess of any of these limits may cause permanent damage
2. Source lead temperature is 25°C. Derate 19.8mW/°C for $T_L > 54.56^\circ\text{C}$
3. Thermal resistance measured using 150°C Infra-Red Microscopy Technique.

MGA-30489 Electrical Specification [4]

$T_C = 25^\circ\text{C}$, $Z_o = 50\Omega$, $V_d = 5\text{V}$, unless noted

| Symbol | Parameter and Test Condition | Frequency | Units | Min. | Typ. | Max. |
|----------|--------------------------------------|---|-------|------|----------------------------|------|
| I_{ds} | Quiescent Current | N/A | mA | 80 | 97 | 120 |
| NF | Noise Figure | 0.45GHz 0.9GHz 1.9GHz 2.5GHz | dB | - | 2.8 3 3 3.5 | 3.6 |
| Gain | Gain | 0.45GHz 0.9GHz 1.9GHz 2.5GHz | dB | 11.8 | 19.3 16.5 13.3 12 | 14.8 |
| OIP3 [5] | Output Third Order Intercept Point | 0.45GHz ⁽²⁾ 0.9GHz ⁽²⁾ 1.9GHz ⁽²⁾ 2.5GHz ⁽²⁾ | dBm | 36.5 | 40.5 40.5 39 39 | - |
| P1dB | Output Power at 1dB Gain Compression | 0.45GHz 0.9GHz 1.9GHz 2.5GHz | dBm | 22.5 | 23.5 23.5 23.3 23 | - |
| PAE | Power Added Efficiency at P1dB | 0.45GHz 0.9GHz 1.9GHz 2.5GHz | % | | 44 43 40 37 | - |
| IRL | Input Return Loss | 0.45GHz 0.9GHz 1.9GHz 2.5GHz | dB | | 10.5 11 15 18 | |
| ORL | Output Return Loss | 0.45GHz 0.9GHz 1.9GHz 2.5GHz | dB | | 9.5 12 14.5 12 | |
| ISOL | Isolation | 0.45GHz 0.9GHz 1.9GHz 2.5GHz | dB | | 29 28 25.5 24 | |

Notes:

4. Measurements obtained from a test circuit described in Figure 43.

5. OIP3 test condition: $F_1 - F_2 = 10\text{MHz}$, with input power of -10dBm per tone measured at worst case side band.

MGA-30489 Consistency Distribution Chart [1,2]

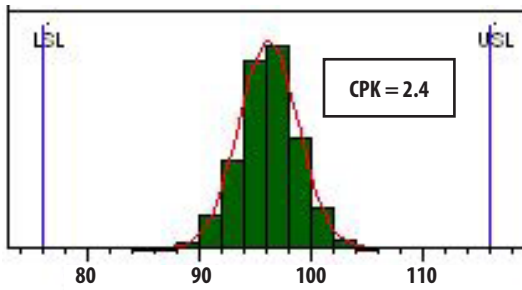

Figure 2. Idd @ 1900MHz, 5V, 97mA

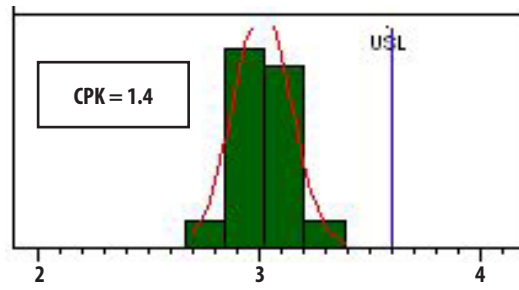

Figure 3. NF @ 1900MHz, 5V, 97mA

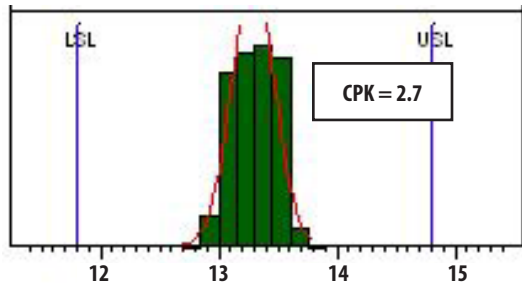

Figure 4. Gain @ 1900MHz, 5V, 97mA

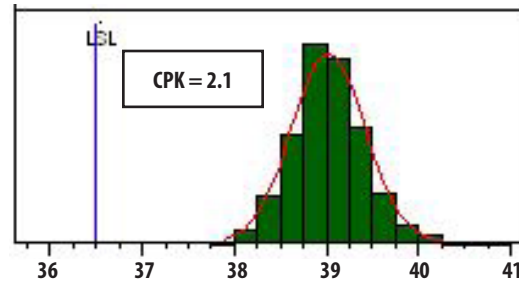

Figure 5. OIP3 @ 1900MHz, 5V, 97mA

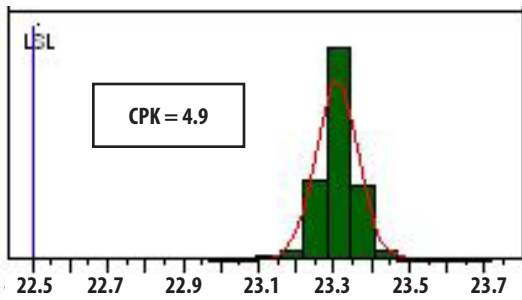

Figure 6. P1dB @ 1900MHz, 5V, 97mA

Notes:

1. Data sample size is 3000 samples taken from 2 different wafers and 2 different lots. Future wafers allocated to this product may have nominal values anywhere between the upper and lower limits
2. Measurements are made on production test board which represents a trade-off between optimal Gain, NF, OIP3 and OP1dB. Circuit losses have been de-embedded from actual measurements.

MGA-30489 Application Circuit Data for 450MHz

$T_c = 25^\circ\text{C}$, $V_d = 5.0\text{V}$, $I_d = 97\text{mA}$

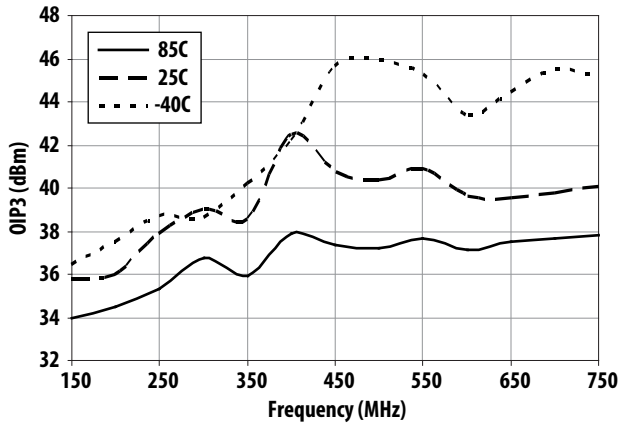

Figure 7. OIP3 vs Frequency and Temperature

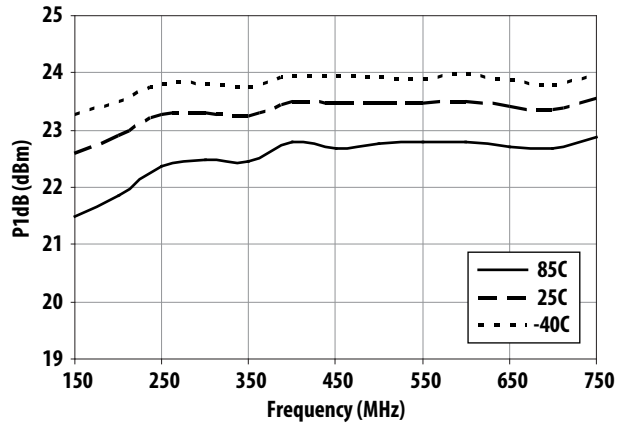

Figure 8. P1dB vs Frequency and Temperature

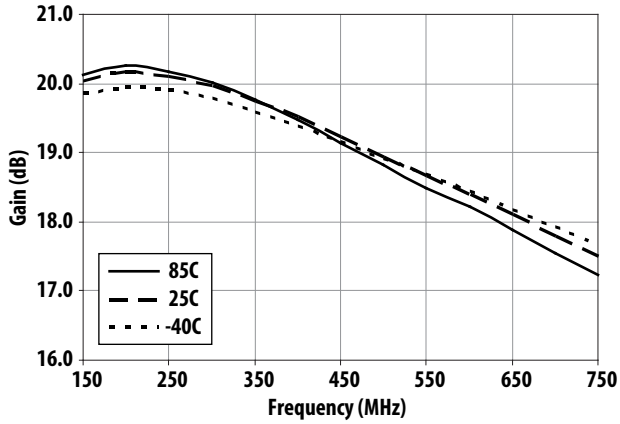

Figure 9. Gain vs Frequency and Temperature

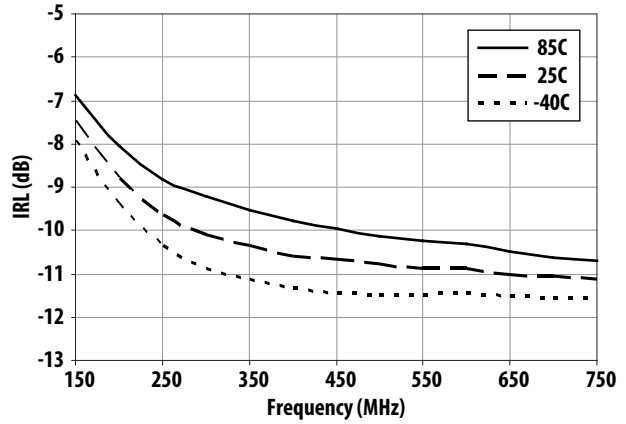

Figure 10. IRL vs Frequency and Temperature

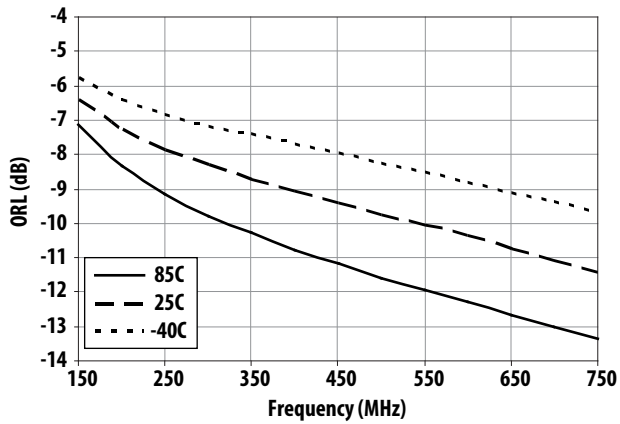

Figure 11. ORL vs Frequency and Temperature

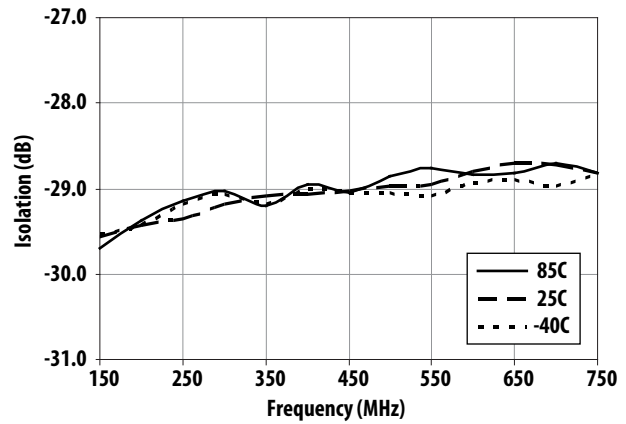

Figure 12. Isolation vs Frequency and Temperature

MGA-30489 Application Circuit Data for 450MHz (cont'd)

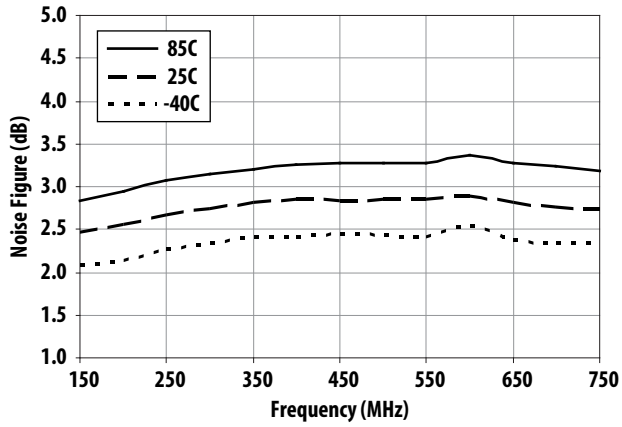

Figure 13. Noise Figure vs Frequency vs Temperature

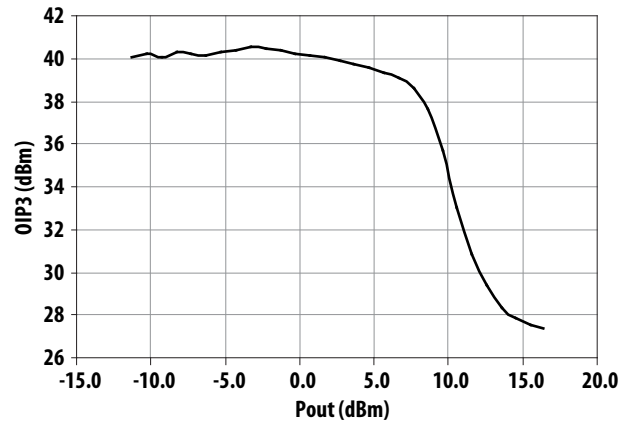

Figure 14. OIP3 vs Output Power at 450MHz

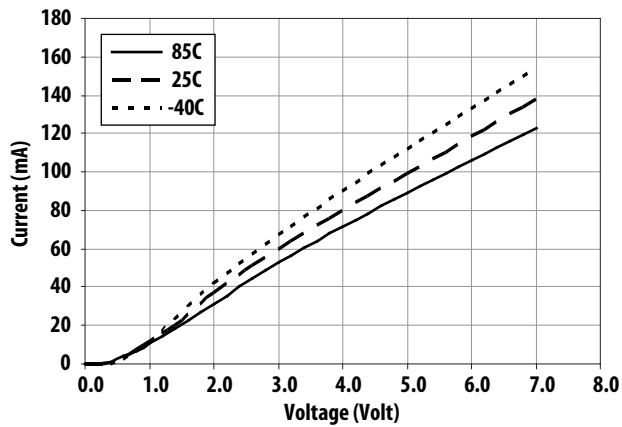

Figure 15. Current vs Voltage and Temperature

MGA-30489 Application Circuit Data for 900MHz

$T_c = 25^\circ\text{C}$, $V_d = 5.0\text{V}$, $I_d = 97\text{mA}$

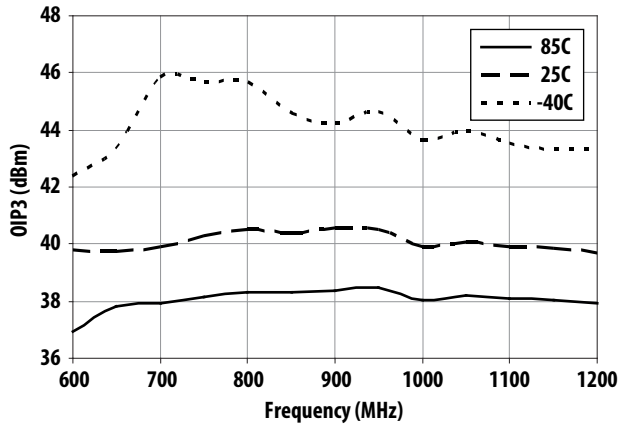

Figure 16. OIP3 vs Frequency and Temperature

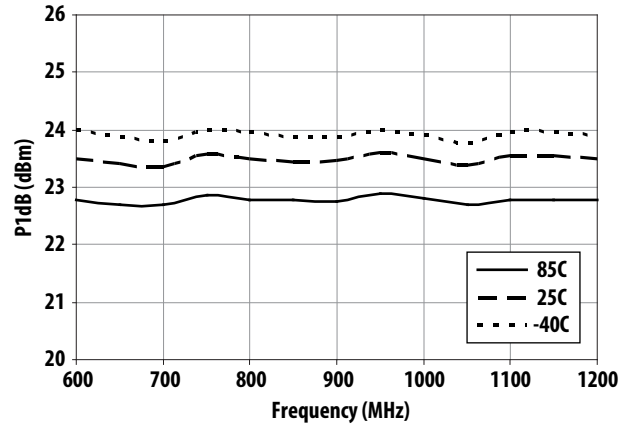

Figure 17. P1dB vs Frequency and Temperature

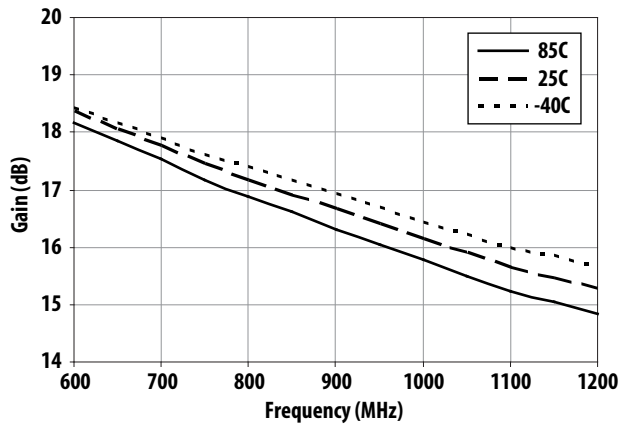

Figure 18. Gain vs Frequency and Temperature

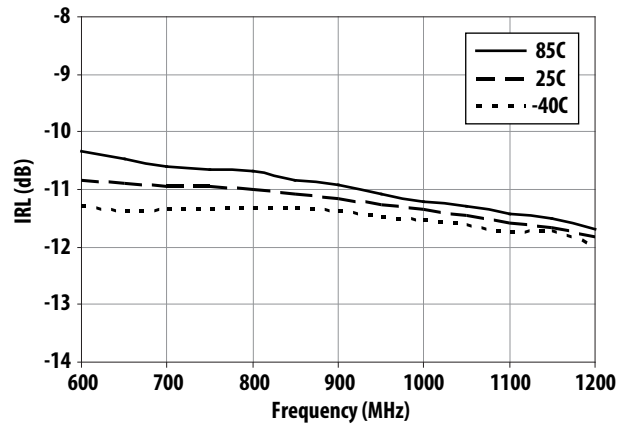

Figure 19. IRL vs Frequency and Temperature

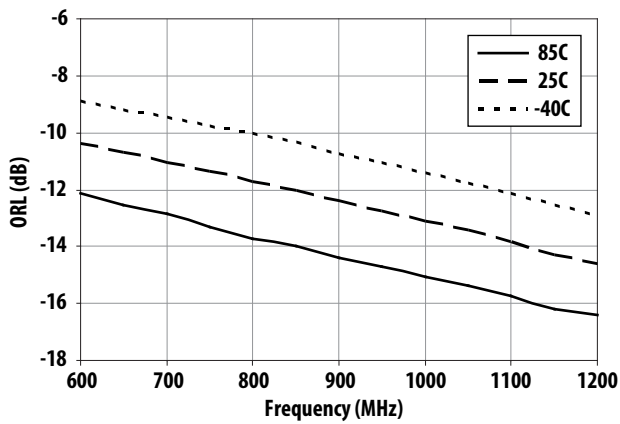

Figure 20. ORL vs Frequency and Temperature

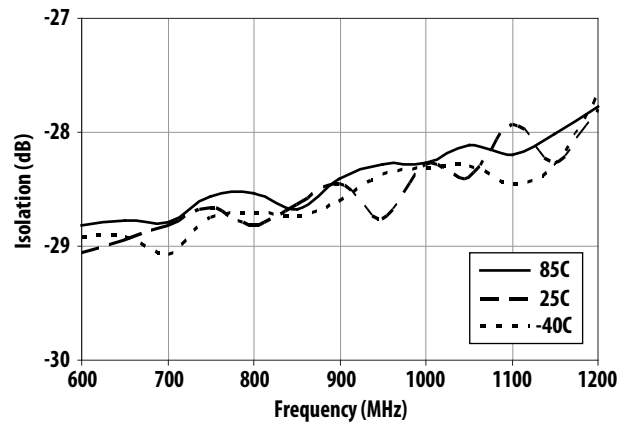

Figure 21. Isolation vs Frequency and Temperature

MGA-30489 Application Circuit Data for 900MHz (cont'd)

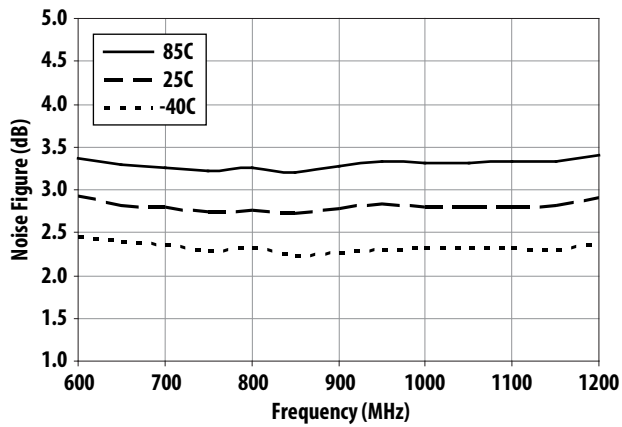

Figure 22. Noise Figure vs Frequency vs Temperature

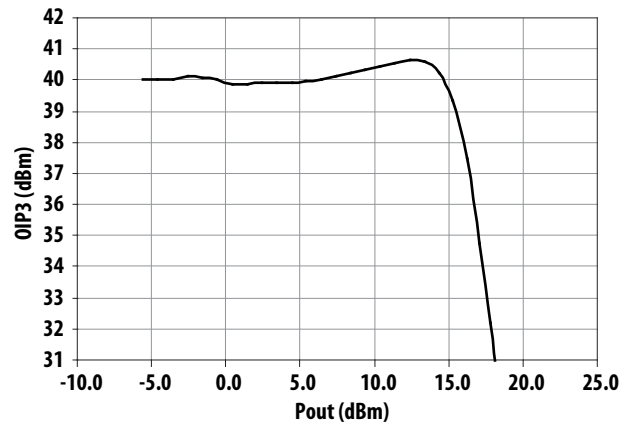

Figure 23. OIP3 vs Output Power at 1900MHz

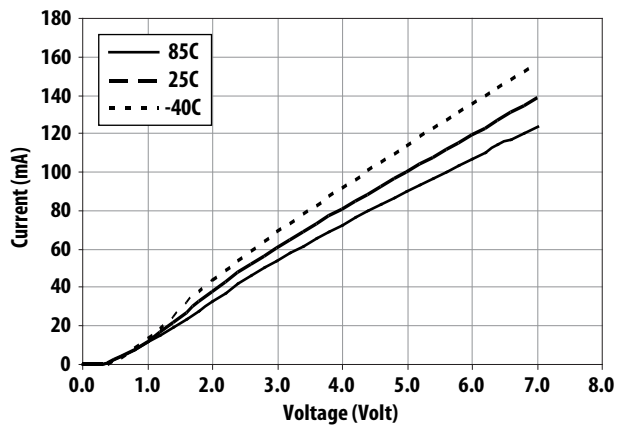

Figure 24. Current vs Voltage and Temperature

MGA-30489 Application Circuit Data for 1900MHz

$T_c = 25^\circ\text{C}$, $V_d = 5.0\text{V}$, $I_d = 97\text{mA}$

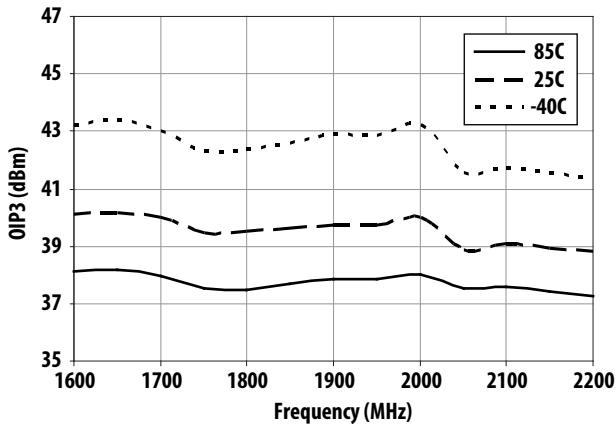

Figure 25. OIP3 vs Frequency and Temperature

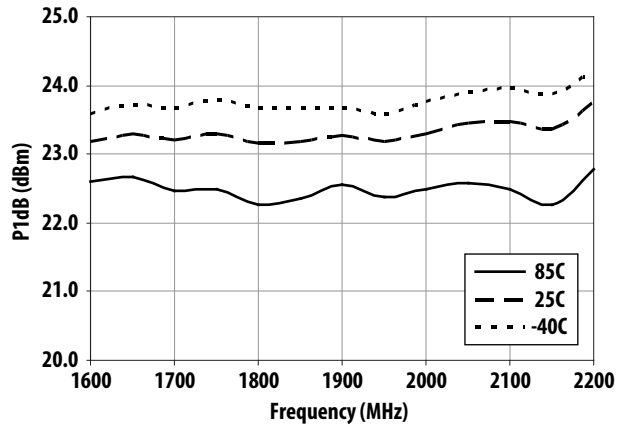

Figure 26. P1dB vs Frequency and Temperature

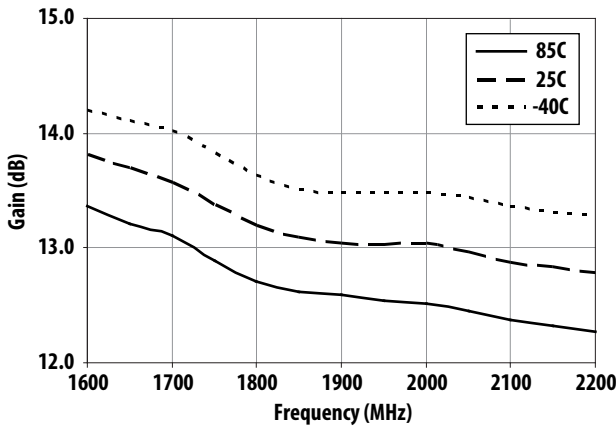

Figure 27. Gain vs Frequency and Temperature

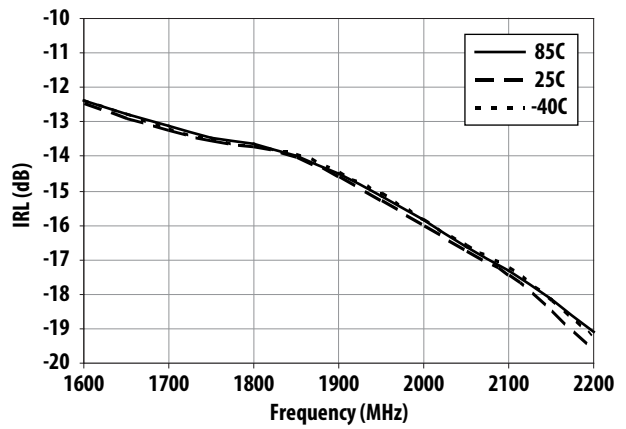

Figure 28. IRL vs Frequency and Temperature

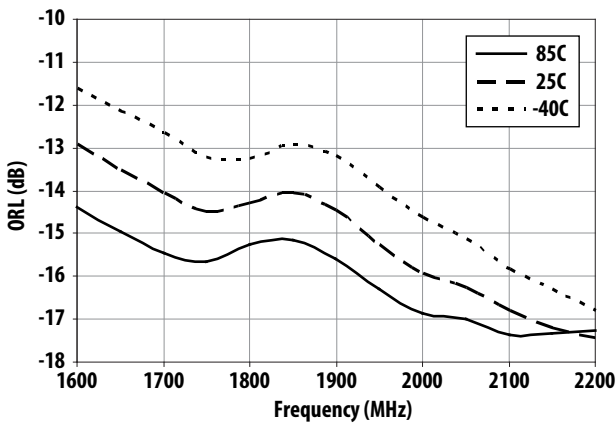

Figure 29. ORL vs Frequency and Temperature

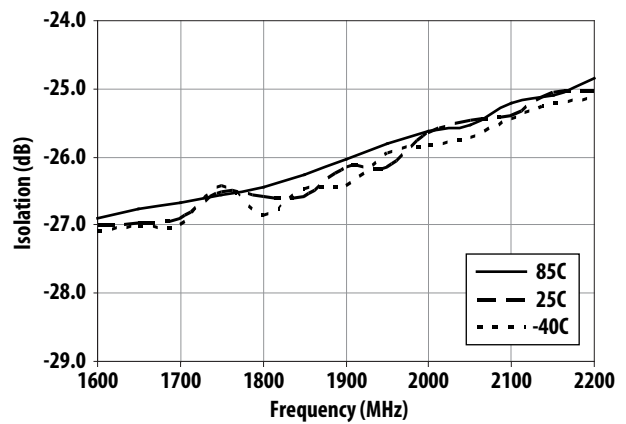

Figure 30. Isolation vs Frequency and Temperature

MGA-30489 Application Circuit Data for 1900MHz (cont'd)

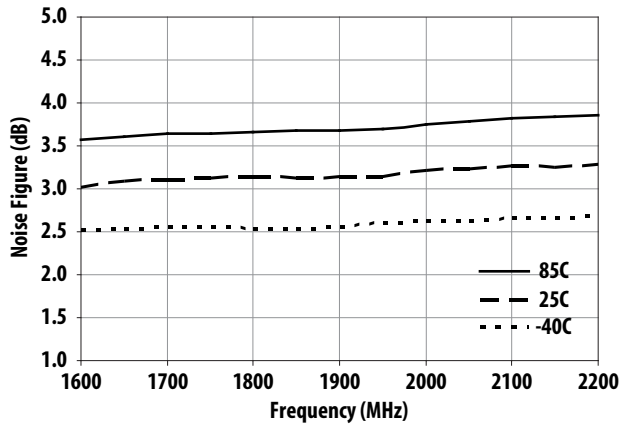

Figure 31. Noise Figure vs Frequency vs Temperature

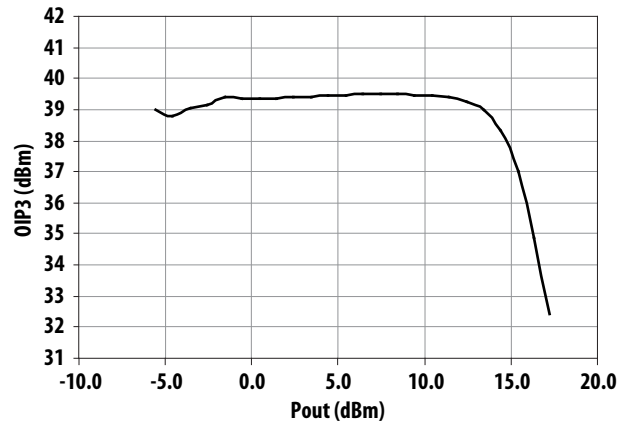

Figure 32. OIP3 vs Output Power at 1900MHz

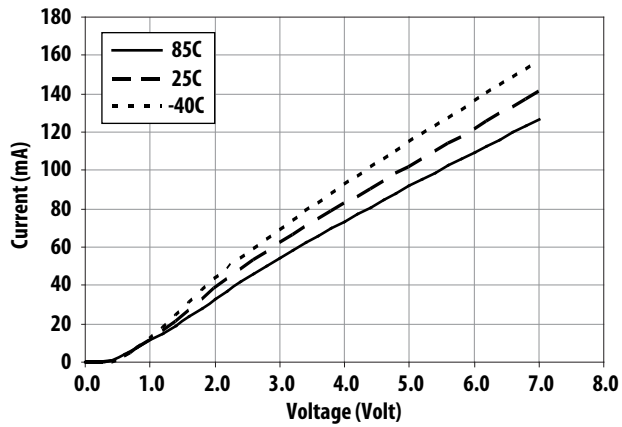

Figure 33. Current vs Voltage and Temperature

MGA-30489 Application Circuit Data for 2500MHz

$T_c = 25^\circ\text{C}$, $V_d = 5.0\text{V}$, $I_d = 97\text{mA}$

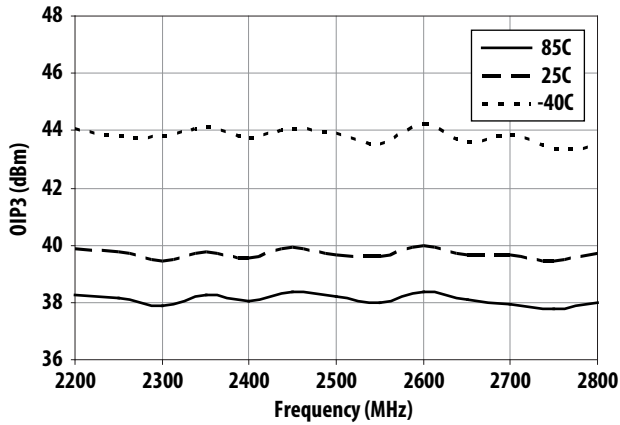

Figure 34. OIP3 vs Frequency and Temperature

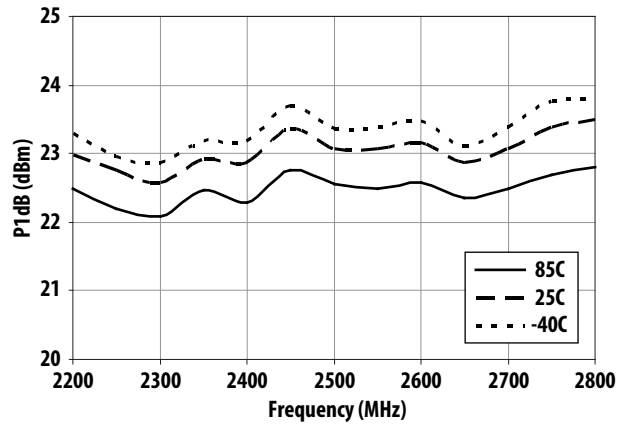

Figure 35. P1dB vs Frequency and Temperature

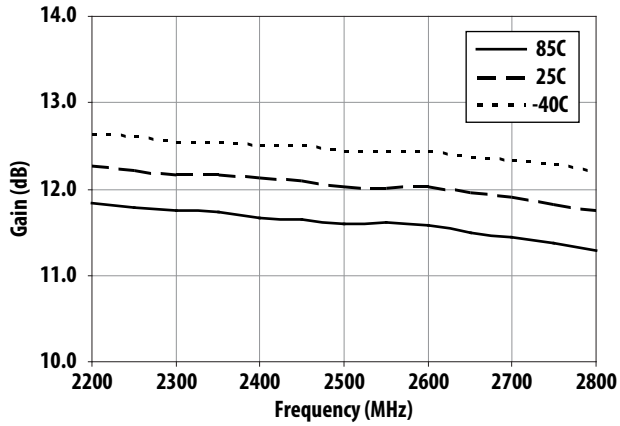

Figure 36. Gain vs Frequency and Temperature

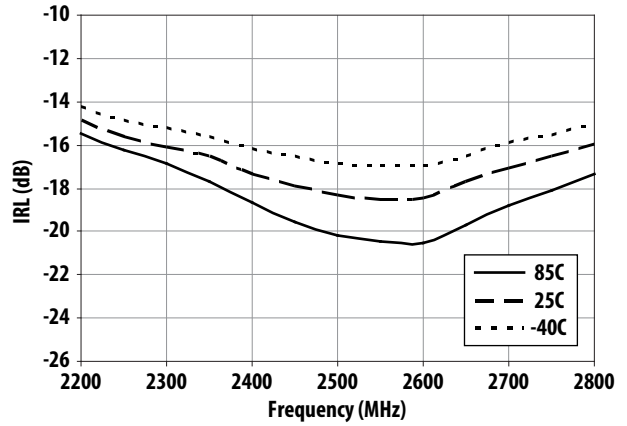

Figure 37. IRL vs Frequency and Temperature

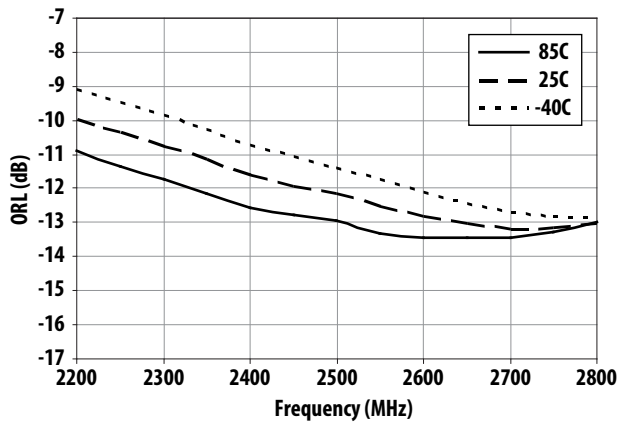

Figure 38. ORL vs Frequency and Temperature

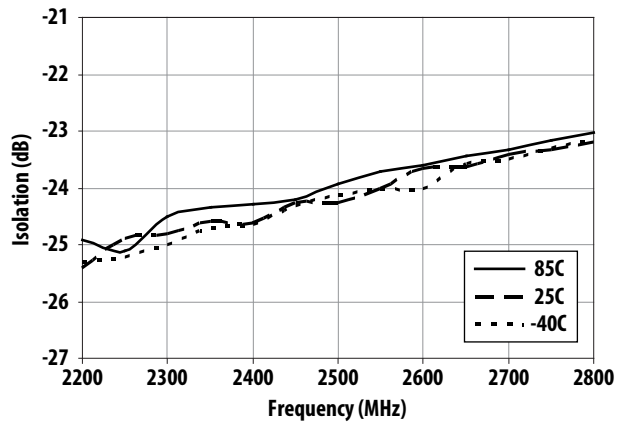

Figure 39. Isolation vs Frequency and Temperature

MGA-30489 Application Circuit Data for 2500MHz (cont'd)

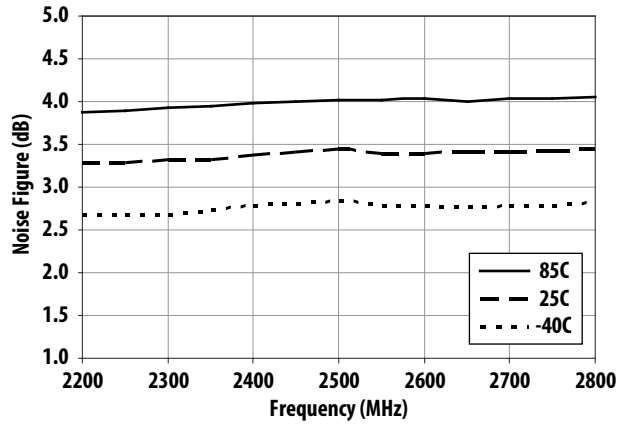

Figure 40. Noise Figure vs Frequency vs Temperature

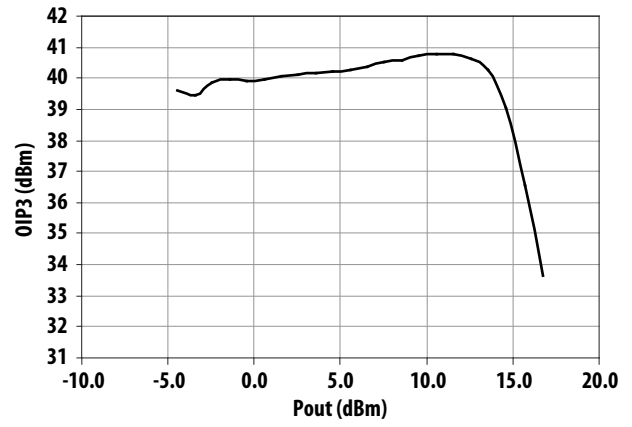

Figure 41. OIP3 vs Output Power at 1900MHz

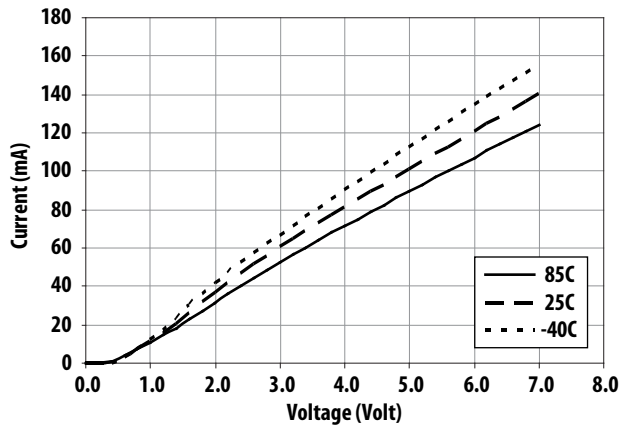

Figure 42. Current vs Voltage and Temperature

Application Circuit Description and Layout

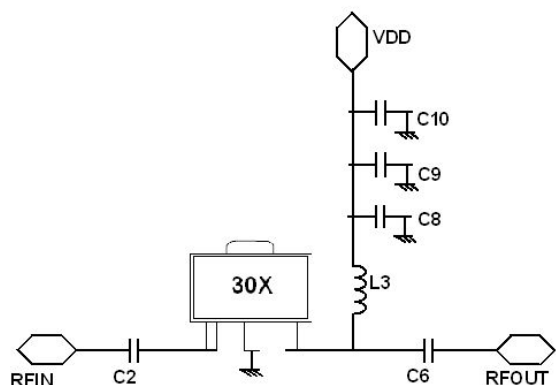

Figure 43. Circuit diagram

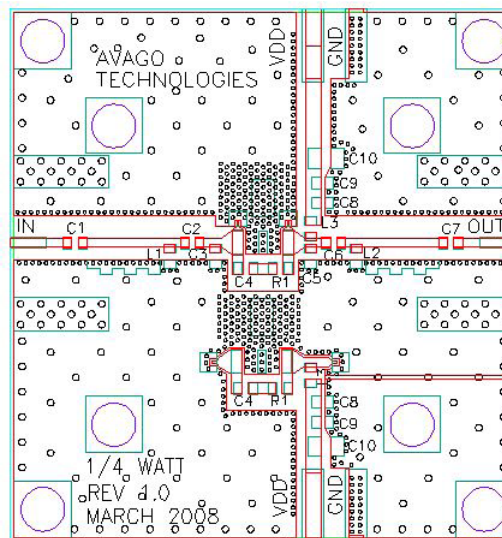

Figure 44. Demoboard

Bill of Materials

| | | Description | | | | | | | |
|----------------|------|-------------|--------------|------------|--------------|------------|--------------|------------|--------------|
| | | For 0.45GHz | | For 0.9GHz | | For 1.9GHz | | For 2.5GHz | |
| Circuit Symbol | Size | Value | Manufacturer | Value | Manufacturer | Value | Manufacturer | Value | Manufacturer |
| C1 | 0402 | 00hm | NR | 00hm | NR | 00hm | NR | 00hm | NR |
| C2 | 0402 | 100pF | MURATA | 100pF | MURATA | 100pF | MURATA | 100pF | MURATA |
| C3 | 0402 | NA | NR | NA | NR | NA | NR | NA | NR |
| C4 | 0402 | NA | NR | NA | NR | NA | NR | NA | NR |
| C5 | 0402 | NA | NR | NA | NR | NA | NR | NA | NR |
| C6 | 0402 | 100pF | MURATA | 100pF | MURATA | 100pF | MURATA | 100pF | MURATA |
| C7 | 0402 | 00hm | NR | 00hm | NR | 00hm | NR | 00hm | NR |
| C8 | 0402 | 10pF | MURATA | 10pF | MURATA | 10pF | MURATA | 2.7pF | MURATA |
| C9 | 0402 | 0.1uF | MURATA | 0.1uF | MURATA | 0.1uF | MURATA | 0.1uF | MURATA |
| C10 | 0603 | 2.2uF | MURATA | 2.2uF | MURATA | 2.2uF | MURATA | 2.2uF | MURATA |
| L1 | 0402 | NA | NR | NA | NR | NA | NR | NA | NR |
| L2 | 0402 | NA | NR | NA | NR | NA | NR | NA | NR |
| L3 | 0402 | 47nH | MURATA | 47nH | MURATA | 10nH | MURATA | 3.0nH | MURATA |
| R1 | 0402 | NA | NR | NA | NR | NA | NR | NA | NR |

Note: NR – not required in actual PCB design

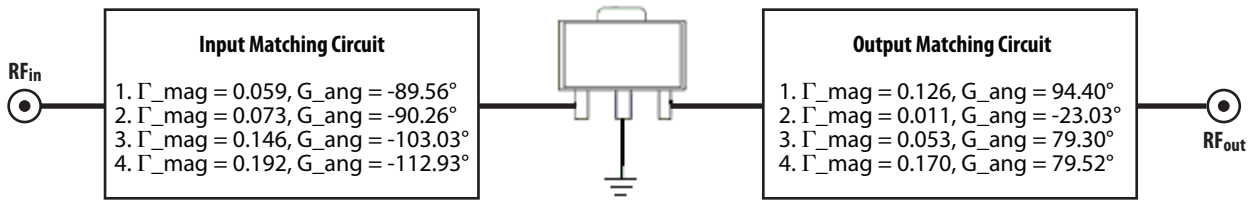

Figure 45. Gamma location for Demoboards

MGA-30489 is a input fully matched and output pre-matched component. To bias MGA-30489, a +5V supply (Vdd) is connected to the output pin thru a RF choke, L3 (which isolates the inband signal from the DC supply). The bypass capacitor helps to eliminate out of low band frequency signals from the power supply, C8, C9 and C10.

The L3 and C8 also acts as the output tuning circuitry. Blocking capacitors are required for its input (C2) and output (C6), to isolate the supply voltage from succeeding circuits. The circuit topology at its output port is changed to achieve best OIP3 while meeting typical specifications for other parameters.

MGA-30489 Typical Scatter Parameters

$T_c = 25^\circ\text{C}$, $V_d = 5.0\text{V}$, $I_d = 97\text{mA}$, $Z_0 = 50\Omega$

| Freq GHz | S11 | S11 | S11 | S21 | S21 | S21 | S12 | S12 | S12 | S22 | S22 | S22 | K |
|-------------|-------|--------|-------|--------|--------|-------|-------|--------|-------|-------|--------|-------|--------|
| | Mag. | Ang. | dB | Mag. | Ang. | dB | Mag. | Ang. | dB | Mag. | Ang. | dB | |
| 0.10 | 0.186 | -45.8 | -14.6 | 11.598 | 159.0 | 21.3 | 0.038 | 3.7 | -28.4 | 0.313 | -173.9 | -10.1 | 1.154 |
| 0.20 | 0.184 | -61.3 | -14.7 | 11.028 | 149.2 | 20.8 | 0.038 | 0.1 | -28.3 | 0.300 | 174.2 | -10.5 | 1.209 |
| 0.30 | 0.184 | -86.6 | -14.7 | 10.345 | 137.4 | 20.3 | 0.038 | -2.2 | -28.3 | 0.293 | 165.7 | -10.7 | 1.281 |
| 0.40 | 0.190 | -103.9 | -14.4 | 9.696 | 127.0 | 19.7 | 0.038 | -2.9 | -28.3 | 0.290 | 154.4 | -10.8 | 1.356 |
| 0.50 | 0.208 | -119.2 | -13.6 | 9.009 | 116.9 | 19.1 | 0.039 | -4.3 | -28.2 | 0.274 | 149.8 | -11.3 | 1.425 |
| 0.60 | 0.220 | -132.4 | -13.2 | 8.378 | 107.5 | 18.5 | 0.040 | -5.5 | -28.0 | 0.260 | 146.4 | -11.7 | 1.495 |
| 0.70 | 0.229 | -144.5 | -12.8 | 7.793 | 98.6 | 17.8 | 0.041 | -6.9 | -27.8 | 0.248 | 142.8 | -12.1 | 1.562 |
| 0.80 | 0.235 | -155.6 | -12.6 | 7.280 | 90.5 | 17.2 | 0.042 | -8.5 | -27.6 | 0.238 | 139.9 | -12.5 | 1.624 |
| 0.90 | 0.239 | -166.4 | -12.4 | 6.818 | 82.6 | 16.7 | 0.043 | -10.4 | -27.3 | 0.229 | 137.1 | -12.8 | 1.681 |
| 1.00 | 0.242 | -176.6 | -12.3 | 6.417 | 75.3 | 16.1 | 0.044 | -12.2 | -27.1 | 0.219 | 134.6 | -13.2 | 1.731 |
| 1.10 | 0.244 | 173.5 | -12.3 | 6.063 | 68.1 | 15.7 | 0.046 | -14.5 | -26.8 | 0.212 | 132.0 | -13.5 | 1.775 |
| 1.20 | 0.246 | 163.7 | -12.2 | 5.756 | 61.3 | 15.2 | 0.047 | -16.9 | -26.5 | 0.202 | 129.8 | -13.9 | 1.810 |
| 1.30 | 0.247 | 154.1 | -12.1 | 5.480 | 54.7 | 14.8 | 0.049 | -19.5 | -26.2 | 0.194 | 127.5 | -14.2 | 1.844 |
| 1.40 | 0.249 | 144.8 | -12.1 | 5.245 | 48.3 | 14.4 | 0.050 | -22.1 | -26.0 | 0.184 | 125.5 | -14.7 | 1.869 |
| 1.50 | 0.246 | 137.8 | -12.2 | 5.049 | 42.0 | 14.1 | 0.052 | -25.0 | -25.7 | 0.172 | 119.1 | -15.3 | 1.885 |
| 1.60 | 0.245 | 130.2 | -12.2 | 4.881 | 35.6 | 13.8 | 0.054 | -28.2 | -25.3 | 0.169 | 112.7 | -15.5 | 1.887 |
| 1.70 | 0.245 | 122.1 | -12.2 | 4.729 | 29.4 | 13.5 | 0.056 | -31.5 | -25.1 | 0.162 | 109.0 | -15.8 | 1.889 |
| 1.80 | 0.246 | 113.5 | -12.2 | 4.600 | 23.2 | 13.3 | 0.058 | -35.1 | -24.8 | 0.155 | 105.6 | -16.2 | 1.886 |
| 1.90 | 0.247 | 105.1 | -12.2 | 4.481 | 16.9 | 13.0 | 0.060 | -38.9 | -24.5 | 0.147 | 102.0 | -16.6 | 1.880 |
| 2.00 | 0.246 | 96.6 | -12.2 | 4.382 | 10.7 | 12.8 | 0.061 | -42.8 | -24.2 | 0.139 | 99.5 | -17.1 | 1.868 |
| 2.10 | 0.246 | 88.0 | -12.2 | 4.303 | 4.5 | 12.7 | 0.063 | -46.9 | -24.0 | 0.132 | 97.0 | -17.6 | 1.849 |
| 2.20 | 0.247 | 79.2 | -12.2 | 4.225 | -1.8 | 12.5 | 0.065 | -51.2 | -23.7 | 0.124 | 95.7 | -18.1 | 1.834 |
| 2.30 | 0.241 | 69.4 | -12.4 | 4.179 | -8.0 | 12.4 | 0.068 | -55.6 | -23.4 | 0.116 | 94.3 | -18.7 | 1.804 |
| 2.40 | 0.241 | 61.7 | -12.4 | 4.149 | -14.6 | 12.4 | 0.069 | -60.8 | -23.2 | 0.115 | 95.4 | -18.8 | 1.778 |
| 2.50 | 0.235 | 51.9 | -12.6 | 4.118 | -21.4 | 12.3 | 0.072 | -65.8 | -22.9 | 0.107 | 97.1 | -19.4 | 1.745 |
| 3.00 | 0.171 | -5.6 | -15.3 | 4.016 | -58.2 | 12.1 | 0.079 | -96.6 | -22.0 | 0.147 | 121.3 | -16.6 | 1.652 |
| 3.50 | 0.117 | -110.8 | -18.7 | 3.711 | -97.8 | 11.4 | 0.075 | -132.9 | -22.5 | 0.287 | 109.1 | -10.8 | 1.787 |
| 4.00 | 0.318 | 166.3 | -9.9 | 3.435 | -144.5 | 10.7 | 0.064 | 179.4 | -23.8 | 0.459 | 83.8 | -6.8 | 1.838 |
| 5.00 | 0.538 | 46.9 | -5.4 | 1.674 | 122.3 | 4.5 | 0.022 | 35.8 | -33.1 | 0.572 | 13.9 | -4.9 | 6.495 |
| 6.00 | 0.651 | -25.3 | -3.7 | 0.573 | 60.5 | -4.8 | 0.030 | -87.5 | -30.5 | 0.609 | -30.2 | -4.3 | 10.279 |
| 7.00 | 0.827 | -55.2 | -1.6 | 0.286 | 18.1 | -10.9 | 0.035 | -124.9 | -29.1 | 0.723 | -54.2 | -2.8 | 6.850 |
| 8.00 | 0.916 | -102.7 | -0.8 | 0.155 | -36.6 | -16.2 | 0.045 | 178.2 | -26.9 | 0.755 | -95.3 | -2.4 | 4.238 |
| 9.00 | 0.893 | -154.6 | -1.0 | 0.071 | -94.6 | -23.0 | 0.030 | 123.1 | -30.4 | 0.803 | -148.3 | -1.9 | 16.074 |
| 10.00 | 0.878 | 174.6 | -1.1 | 0.030 | -135.4 | -30.4 | 0.019 | 88.0 | -34.3 | 0.860 | 180.0 | -1.3 | 50.759 |
| 11.00 | 0.770 | 146.5 | -2.3 | 0.040 | -143.0 | -27.9 | 0.012 | -134.8 | -38.2 | 0.882 | 157.9 | -1.1 | 90.774 |
| 12.00 | 0.896 | 112.6 | -0.9 | 0.034 | -154.3 | -29.3 | 0.018 | -126.6 | -34.7 | 0.886 | 130.7 | -1.1 | 34.318 |
| 13.00 | 0.949 | 90.8 | -0.5 | 0.056 | 172.3 | -25.0 | 0.042 | -177.8 | -27.5 | 0.862 | 97.6 | -1.3 | 6.212 |
| 14.00 | 0.974 | 50.0 | -0.2 | 0.057 | 118.4 | -24.9 | 0.047 | 122.2 | -26.6 | 0.878 | 61.5 | -1.1 | 2.736 |
| 15.00 | 0.915 | 14.7 | -0.8 | 0.044 | 85.9 | -27.1 | 0.038 | 90.0 | -28.4 | 0.916 | 33.6 | -0.8 | 8.234 |
| 16.00 | 0.816 | -33.4 | -1.8 | 0.043 | 67.0 | -27.3 | 0.039 | 72.1 | -28.1 | 0.909 | 10.0 | -0.8 | 17.848 |
| 17.00 | 0.789 | -29.7 | -2.1 | 0.049 | 58.2 | -26.3 | 0.046 | 61.9 | -26.7 | 0.884 | -22.5 | -1.1 | 19.184 |
| 18.00 | 0.922 | -73.9 | -0.7 | 0.061 | 35.3 | -24.3 | 0.059 | 37.7 | -24.6 | 0.840 | -56.6 | -1.5 | 6.913 |
| 19.00 | 0.881 | -116.5 | -1.1 | 0.083 | -7.8 | -21.6 | 0.082 | -5.9 | -21.7 | 0.777 | -85.9 | -2.2 | 7.148 |
| 20.00 | 0.564 | -156.7 | -5.0 | 0.070 | -53.1 | -23.1 | 0.072 | -51.1 | -22.9 | 0.619 | -117.7 | -4.2 | 42.516 |

MGA-30489 Typical Noise Parameters

$T_c = 25^\circ\text{C}$, $V_d = 5.0\text{V}$, $I_d = 97\text{mA}$, $Z_o = 50\Omega$

| Freq (GHz) | F_{\min} (dB) | Γ_{opt} Mag | Γ_{opt} Ang | R_n/Z_o | Ga (dB) |
|------------|-----------------|---------------------------|---------------------------|-----------|---------|
| 0.5 | 2.08 | 0.298 | 15.6 | 0.524 | 19.67 |
| 0.8 | 2.23 | 0.341 | 13.9 | 0.444 | 17.19 |
| 0.9 | 2.25 | 0.259 | 25.3 | 0.456 | 16.89 |
| 1 | 2.31 | 0.272 | 24.9 | 0.446 | 16.27 |
| 1.5 | 2.44 | 0.238 | 33.7 | 0.424 | 14.10 |
| 2 | 2.69 | 0.180 | 60.5 | 0.410 | 13.00 |
| 2.5 | 2.91 | 0.162 | 80.9 | 0.380 | 12.27 |
| 3 | 3.10 | 0.125 | 94.7 | 0.402 | 12.11 |
| 3.5 | 3.11 | 0.189 | 131.6 | 0.296 | 11.67 |
| 4 | 3.38 | 0.234 | 155.3 | 0.288 | 10.85 |
| 4.5 | 3.82 | 0.309 | -179.4 | 0.256 | 9.32 |
| 5 | 4.96 | 0.437 | -159.5 | 0.336 | 7.26 |
| 5.5 | 6.12 | 0.557 | -134.8 | 0.726 | 5.06 |
| 6 | 7.27 | 0.633 | -114.6 | 1.874 | 3.16 |

Part Number Ordering Information

| Part Number | No of Devices | Container |
|----------------|---------------|---------------|
| MGA-30489-BLKG | 100 | 7" Tape/Reel |
| MGA-30489-TR1G | 3000 | 13" Tape/Reel |

SOT89 Package Dimensions

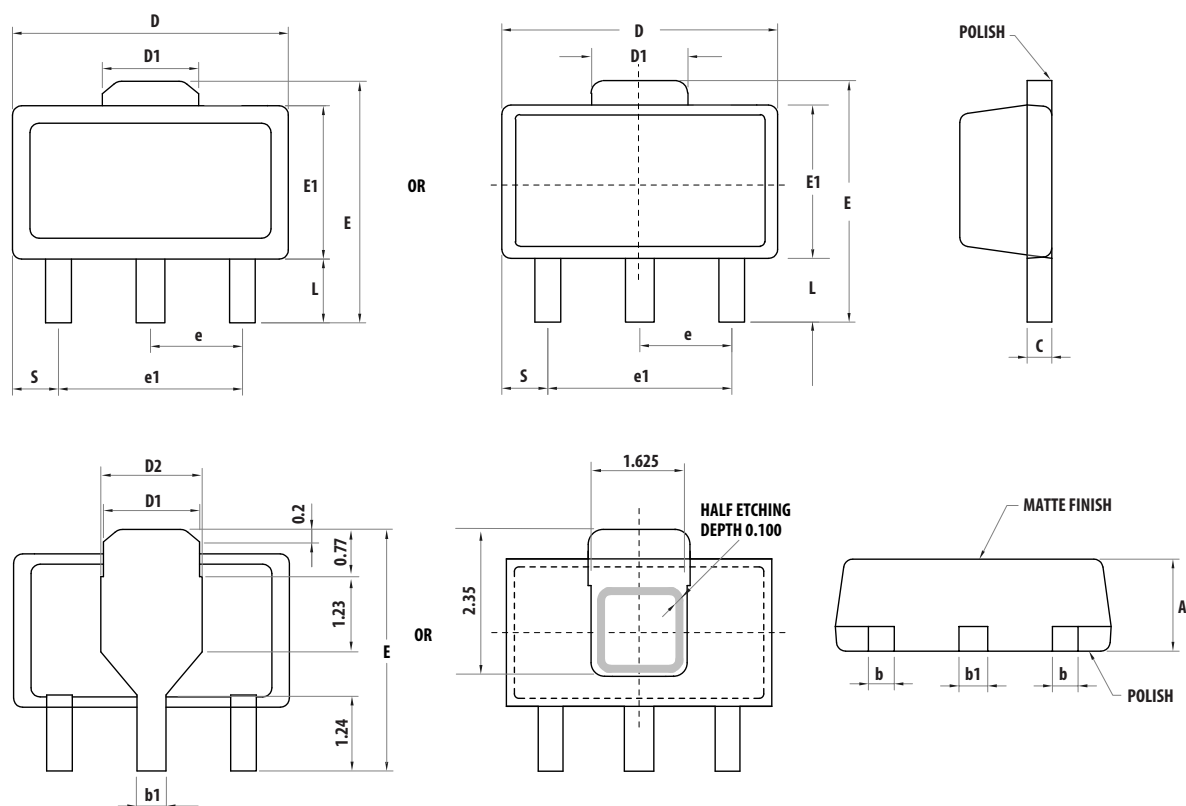

| Symbols | Dimensions in mm | | | Dimensions in inches | | |
|---------|------------------|---------|---------|----------------------|---------|---------|
| | Minimum | Nominal | Maximum | Minimum | Nominal | Maximum |
| A | 1.40 | 1.50 | 1.60 | 0.055 | 0.059 | 0.063 |
| L | 0.89 | 1.04 | 1.20 | 0.0350 | 0.041 | 0.047 |
| b | 0.36 | 0.42 | 0.48 | 0.014 | 0.016 | 0.018 |
| b1 | 0.41 | 0.47 | 0.53 | 0.016 | 0.018 | 0.030 |
| C | 0.38 | 0.40 | 0.43 | 0.014 | 0.015 | 0.017 |
| D | 4.40 | 4.50 | 4.60 | 0.173 | 0.177 | 0.181 |
| D1 | 1.40 | 1.60 | 1.75 | 0.055 | 0.062 | 0.069 |
| D2 | 1.45 | 1.65 | 1.80 | 0.055 | 0.062 | 0.069 |
| E | 3.94 | - | 4.25 | 0.155 | - | 0.167 |
| E1 | 2.40 | 2.50 | 2.60 | 0.094 | 0.098 | 0.102 |
| e1 | 2.90 | 3.00 | 3.10 | 0.114 | 0.118 | 0.122 |
| S | 0.65 | 0.75 | 0.85 | 0.026 | 0.030 | 0.034 |
| e | 1.40 | 1.50 | 1.60 | 0.054 | 0.059 | 0.063 |

Device Orientation

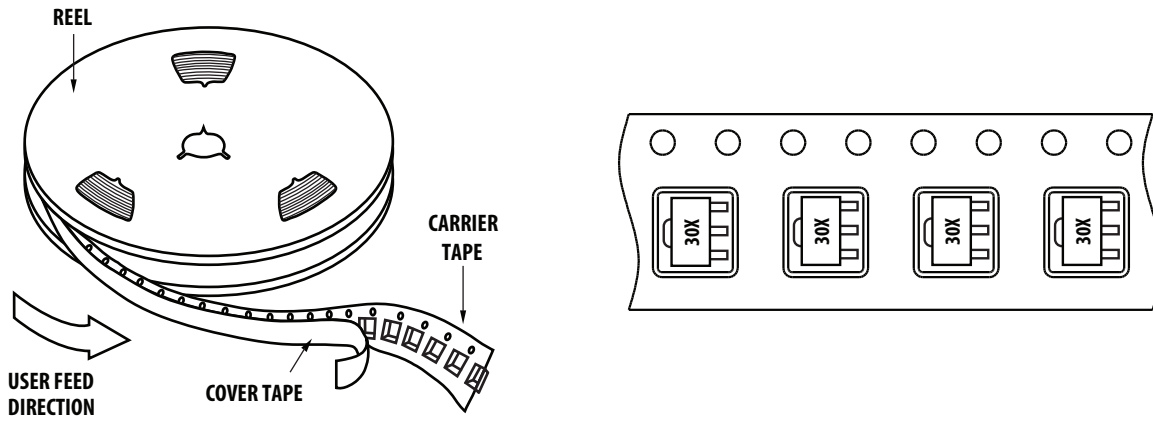

Tape Dimensions

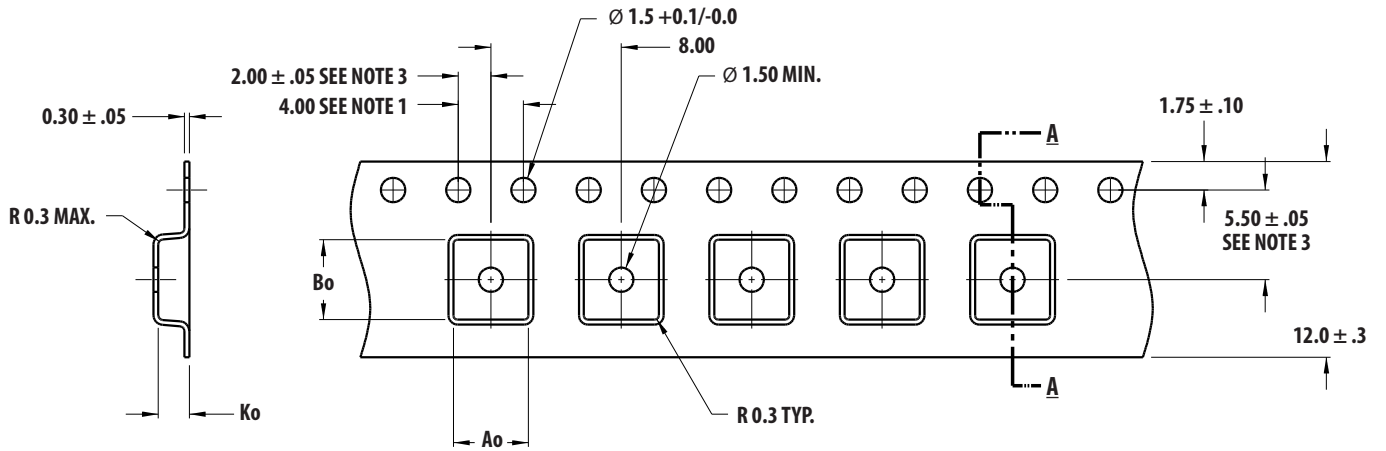

SECTION A - A

Ao = 4.60
Bo = 4.90
Ko = 1.90

DIMENSIONS IN MM

NOTES:

1. 10 SPROCKET HOLE PITCH CUMULATIVE TOLERANCE ± 0.2
2. CAMBER IN COMPLIANCE WITH EIA 481
3. POCKET POSITION RELATIVE TO SPROCKET HOLE MEASURED AS TRUE POSITION OF POCKET, NOT POCKET HOLE

Reel Dimensions – 13" Reel

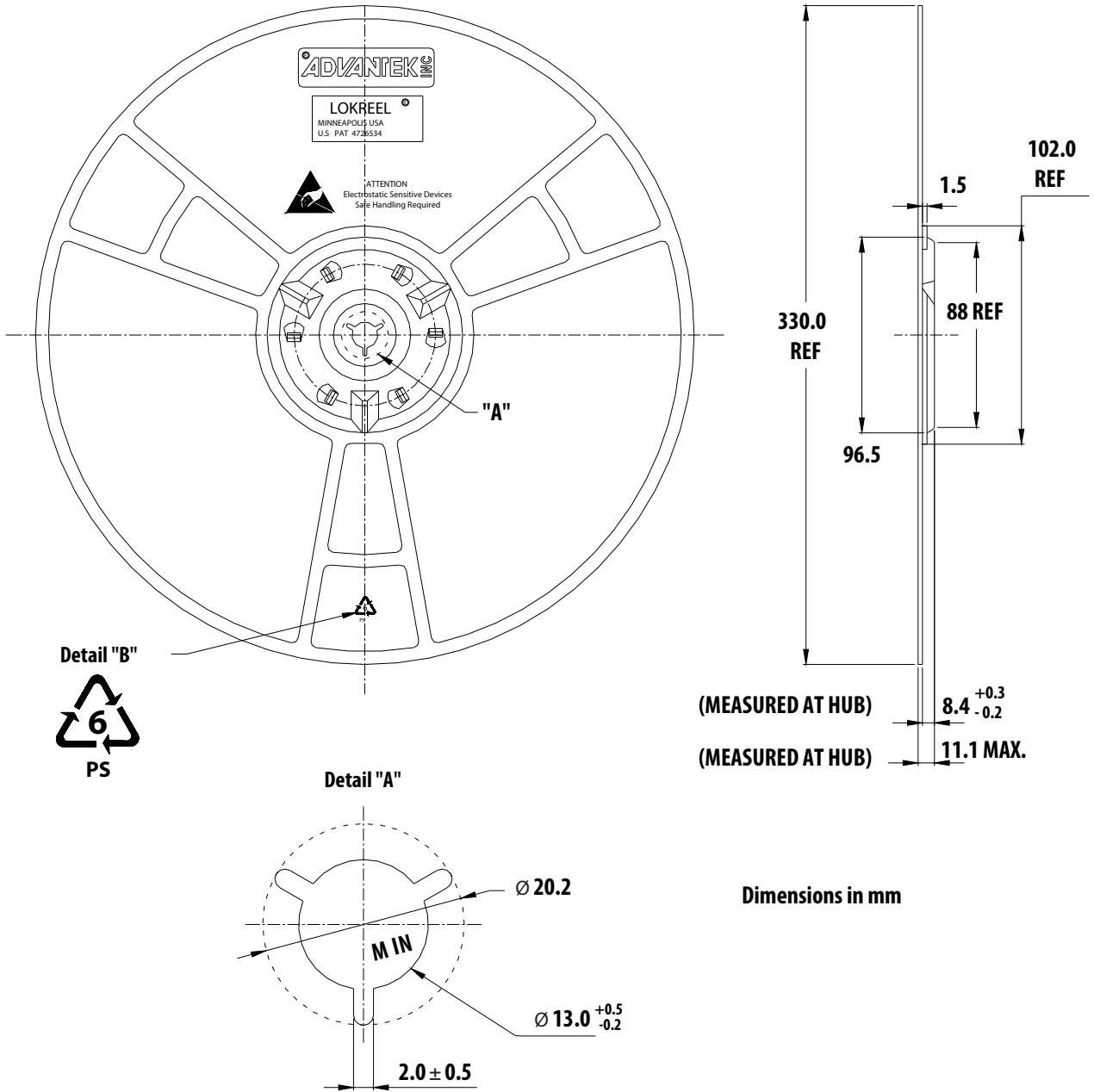

Dimensions in mm

For product information and a complete list of distributors, please go to our web site: www.avagotech.com

Avago, Avago Technologies, and the A logo are trademarks of Avago Technologies in the United States and other countries. Data subject to change. Copyright © 2005-2013 Avago Technologies. All rights reserved. AV02-1764EN - November 11, 2013

